

2-D Birefringence Measurement System

Presentation of PA/WPA Systems

1. Basics of Birefringence Measurement
2. Structure of Polarization Imaging Sensor and Principles
3. Basic Structure of the Systems and Measurement Examples
4. About Range Limitations and our Solution (WPA Series)



1. Basics of Birefringence Measurement

◆ The 3 components of light

Amplitude = brightness 

Wavelength = color 

Direction of the Vibration: **polarization**

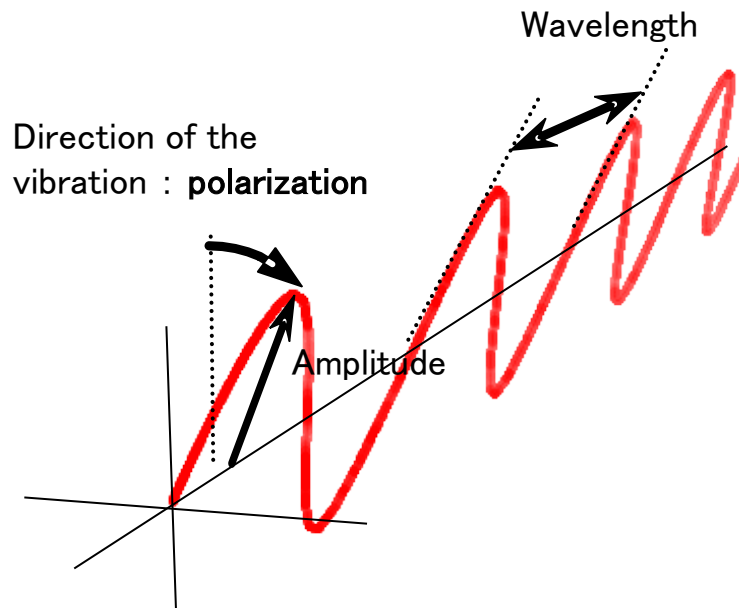

※In contrast to amplitude and wavelength, polarization cannot be recognized by human eye, making it difficult to apprehend intuitively.

◆ Polarization & Polarizers

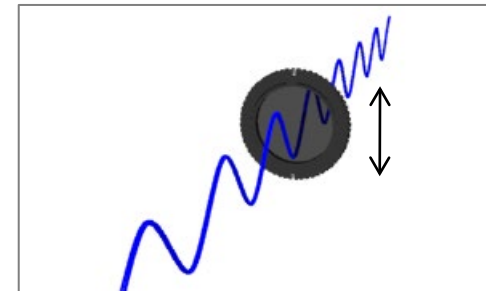

When
Input Direction = Polarizer Direction

100% transmitted

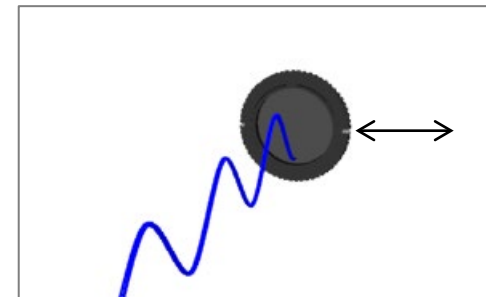

When
Input Direction \perp Polarizer Direction

0% transmitted

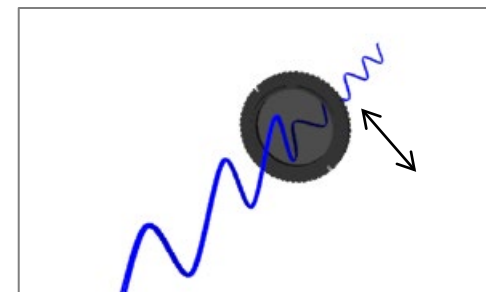

When 45deg. ...

50%透過

【Basic Principle of Polarization Measurement】

Rotating a polarizer and observe the change of intensity transmitted through the polarizer.

Polarization and Birefringence

◆ Refractive index = how easily light passes through the material

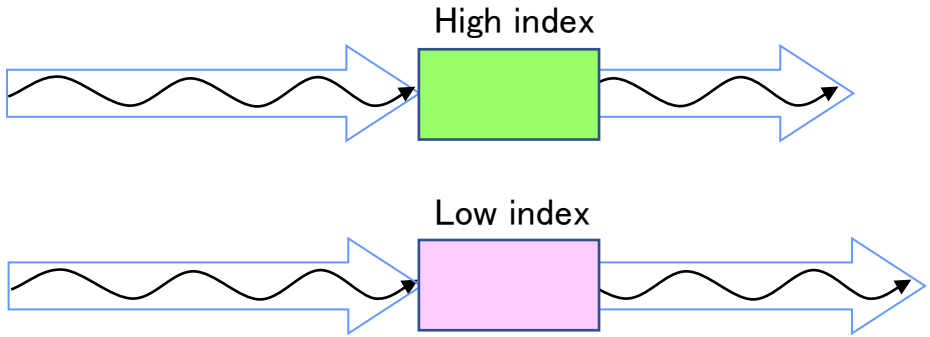

The higher the refractive index is, the more time is needed for light to pass through the material.

※ **Optical length = Refractive Index × Length**
 Example: for glass with index $n = 1.5$, light is slowed down by a factor 1.5

◆ Birefringence = when refractive index depends on light polarization

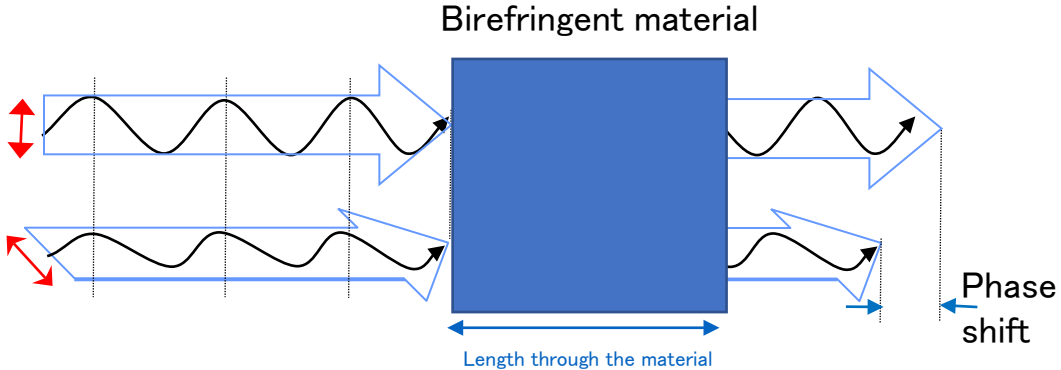

【Example refractive indices】

	Ordinary	Extraordinary	Birefringence (Δn)
Calcite	1.6584	1.4864	0.172
Quartz	1.5443	1.5534	0.0091
Sapphire	1.768	1.76	0.008
Ice	1.309	1.313	0.004

※ **Phase shift = Birefringence × Length**
 Here, we assume that different polarizations are passing through the material at the same point.
 Thus, length is the same \Rightarrow **Phase Shift \propto Birefringence**

Impact of Birefringence on Light Polarization

◆ Phase Shift between Each Polarization Component and Total Polarization Resulting

Every state of polarization existing is the result of a combination of 2 perpendicular components

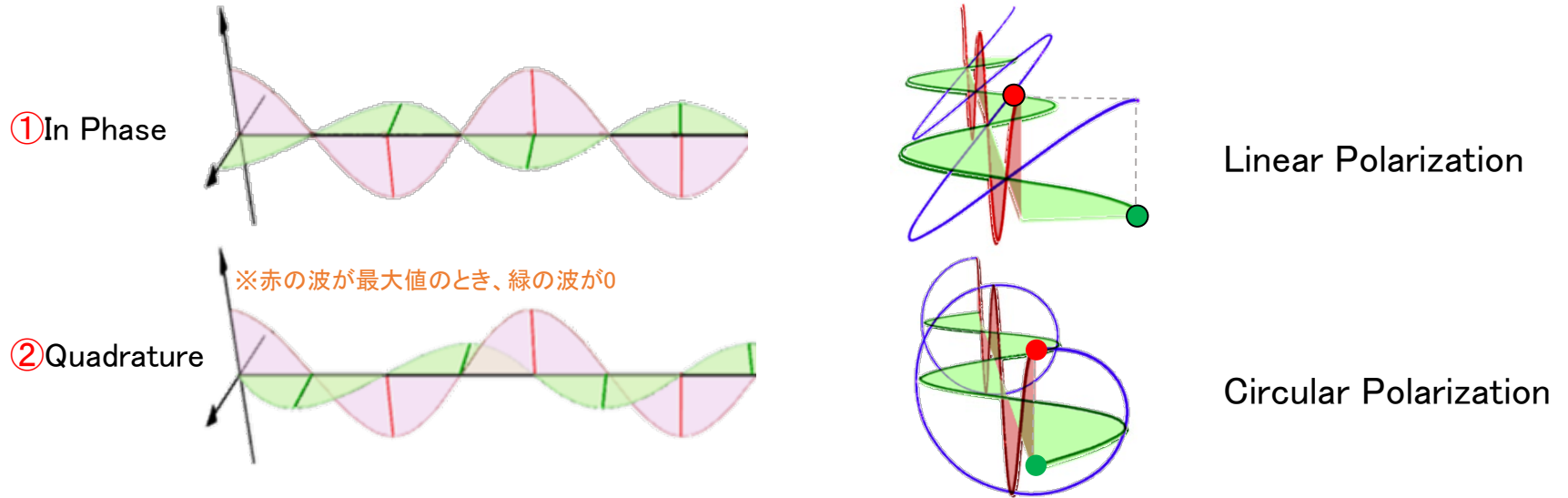

※ Depending on the phase shift between the 2 components, a different state of polarization results

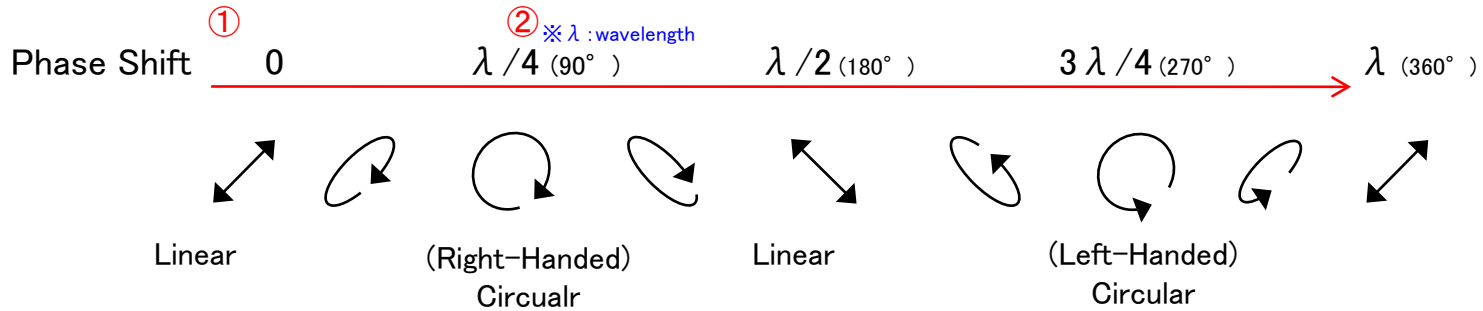

※ Combined with the information of previous page, we understand that

birefringence makes polarization change by introducing a phase shift between the two components

◆ Material exhibiting birefringence makes polarization change

【non birefringent material】

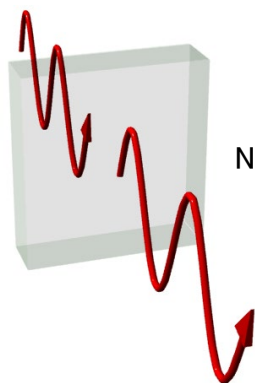

No change in polarization

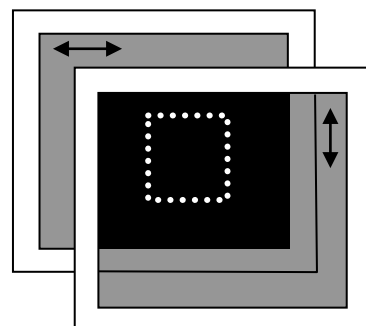

Crossed polarizers (cross Nichols): dark
no light is detected

Crossed polarizers completely shut down
the light trying to go through



A non birefringent material placed between
does not change the situation



A birefringent material placed between the
crossed polarizer appears bright

【birefringent material】

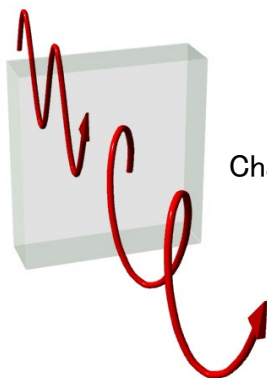

Change of polarization

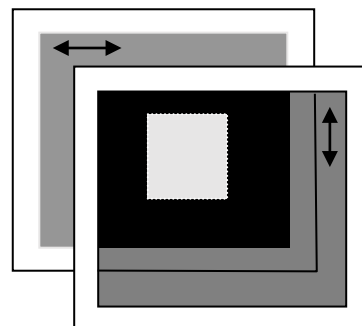

Even with crossed polarizers, light
is detected due the change of polarization
induced by the birefringent material

応力による複屈折の発生

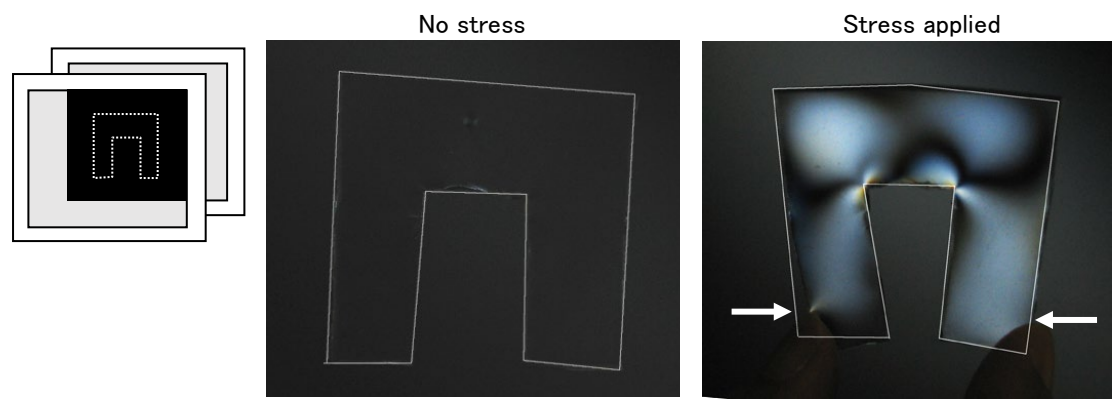

- Even in non birefringent materials, internal stress can induce birefringent behavior
- This phenomenon, called “photo-elasticity”, imply that observed birefringence is proportional to the stress applied to the material. The proportionality constant, referred as the “photo-elasticity constant”, is a property of each material.

$$\text{birefringence} = \beta \times \text{stress [force]} (10^{12}\text{Pa})$$

$$\text{phase shift } \delta \text{ (nm)} = \beta \times \text{thickness } d \text{ (cm)} \times \text{stress [force] } F (10^5 \text{ Pa})$$

~ β is the photo-elastic constant for the particular material [$10^{12}/\text{Pa}$]

For example,
a force of 1MPa applied to a 1mm quartz plate results in a phase shift of:

$$3.5 \times 0.1 \times 10 = 3.5\text{nm}$$

Material	Photo-elastic constant ($10^{-12}/\text{Pa}$)
Quartz	3.5
Polycarbonate	75
Acrylic	6
Glass	0.5
Lead glass	0.005

※Natural birefringence of rock crystal quartz is approx. 0.01 (1.55–1.54). The amount of force to obtain this value by photo-elasticity is 0.003TPa=3GPa, which is very big. In general, birefringence exhibited by the photo-elastic effect is much smaller than in naturally birefringent quartz.

※The major part of the birefringence observed in plastic molded object is thought to originate from molecular orientation, rather than from photo-elasticity. Thus, for this type of object, it is not reasonable to calculate an amount of stress from the birefringence observed. However, differences of birefringence still can be linked to differences of the molding process, thought as a whole. That is why birefringence analysis is a good evaluation technique for plastic molding process.

Evaluating the distribution of birefringence enables the access to information about internal stress and molecular orientation in transparent materials.

- Birefringence in material modifies the polarization of the light going through



- Thus, comparing light polarization in and out allows measuring birefringence in the material



Birefringence Measurement = Polarization Measurement + Difference Computation

※A birefringence measurement system must be, as long as we talk about hardware, a polarization measuring device.

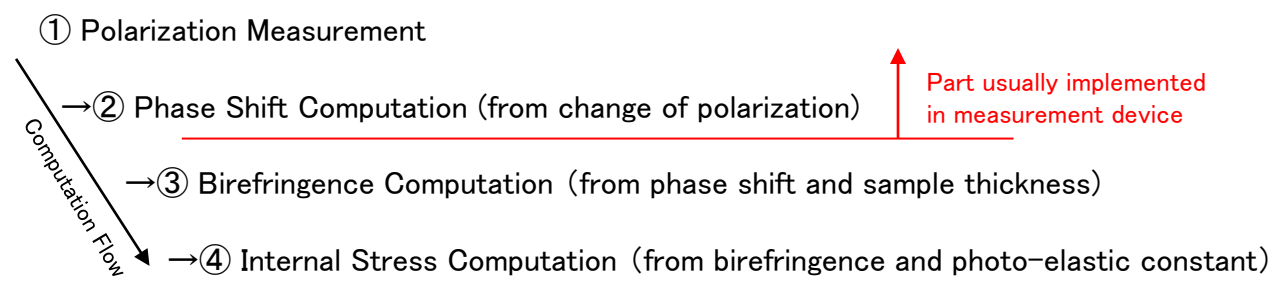
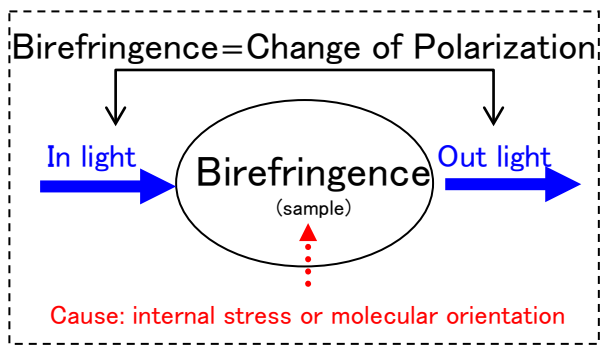

Theoretically, computation of birefringence and internal stress is possible. However, because of the following reasons birefringence measurement device usually provide data for ② phase-shift only:

- a. sample geometry data is not easy to manipulate in a universal manner
- b. phase-shift data is often more relevant than birefringence for most applications
- c. the cause of birefringence is rarely internal stress only, but a combination of factors

The user is then free to keep further the computations based on its own knowledge about his sample geometry and material.

Basic Principles of Polarization Measurement

Looking at the variation of intensity while making polarizing filters rotate is the basic way of measuring polarization.

【Basic structure】

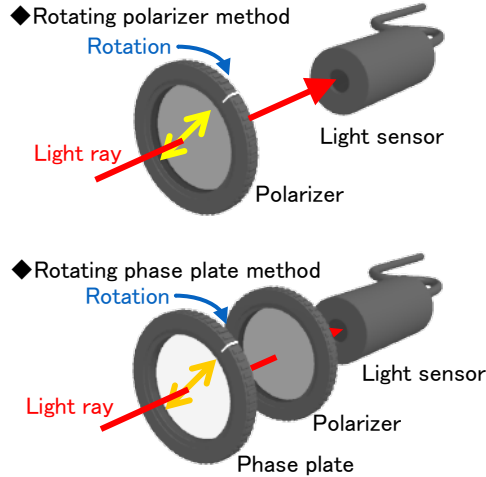

Problems:

- Actual hardware is not as simple as in the drawing in the left (motors, angle encoding units, need as a rigid casing etc.)
- Some time is needed for a rotation to complete → measuring rapidly evolving objects is impossible
- Hard to obtain surface data
- ※ Even now, most system on the market utilizes this structure

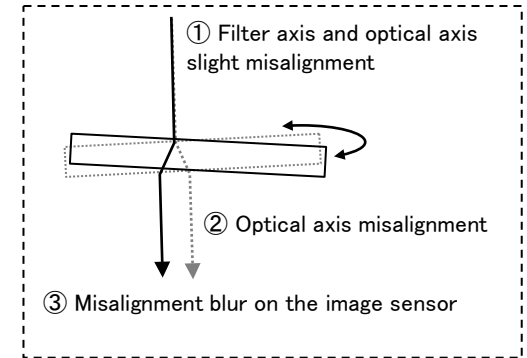

【New structures】

“Optical rotation” using electric signal, using liquid crystal, instead of mechanical rotation

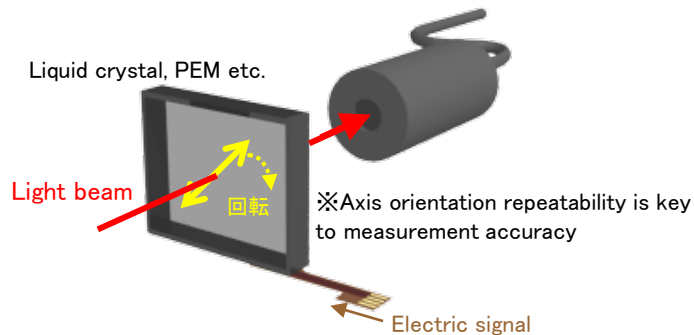

Dispose spatially differently oriented polarization filters, instead of rotation of a unique filter

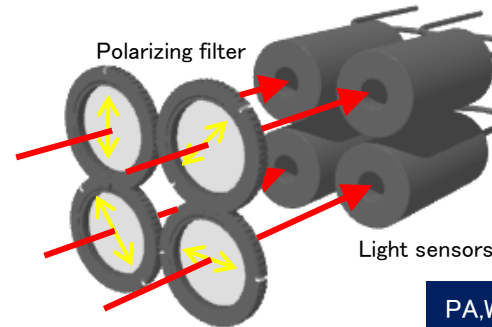

Light sensors are implemented as a CCD image sensor
↓
The technology to put a small filter in front of each CCD pixel is key for this method

PA,WPA Series systems use this method

2. Polarization Imaging Sensor : Structure and Operation Principle

Basic structure of Polarization Imaging Sensor

Microscopic size polarization filters are integrated and placed in front of a CCD image sensor

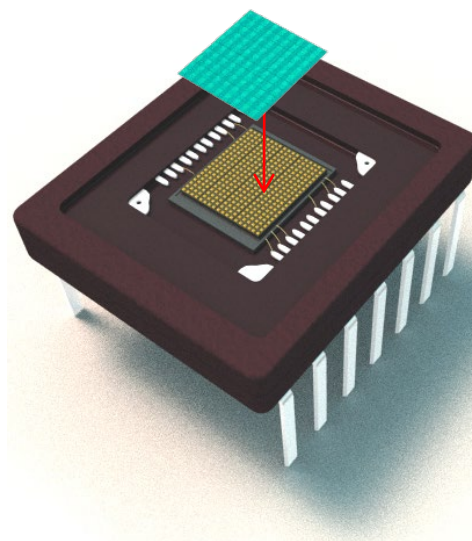
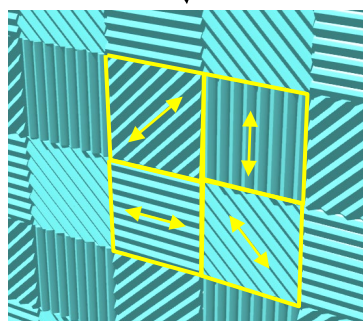
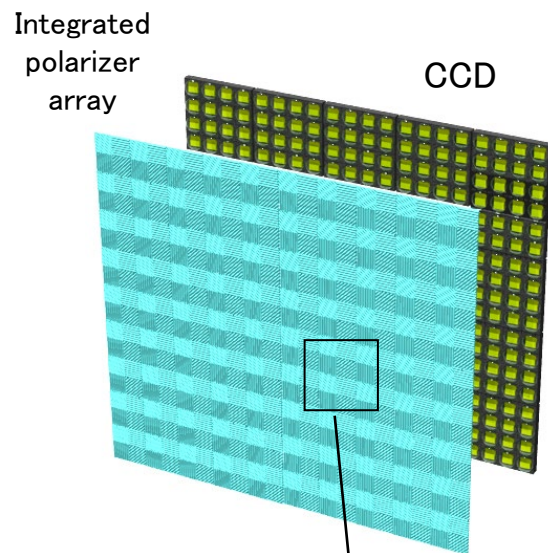

SEM picture of the polarizer array

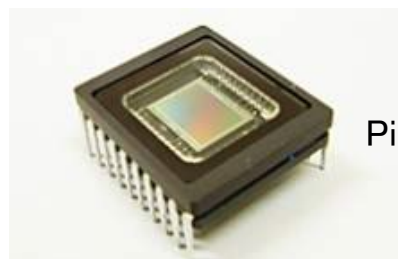
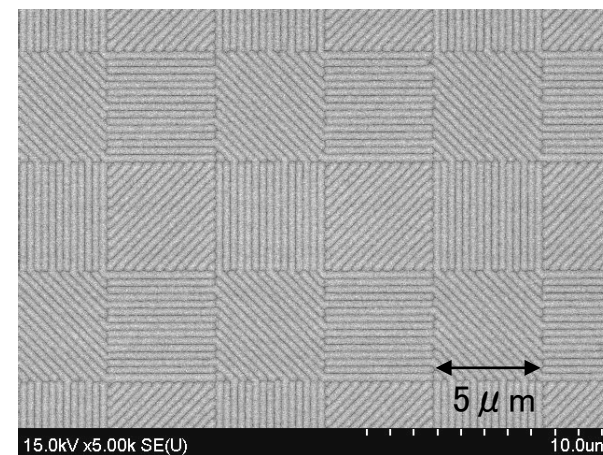

Picture of an actual polarization imaging sensor

Polarization imaging sensor principle

- Computation of polarization information from intensity at 4 neighbor pixels

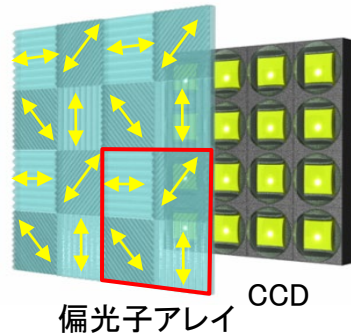

[Relation between input polarization and intensity pattern]

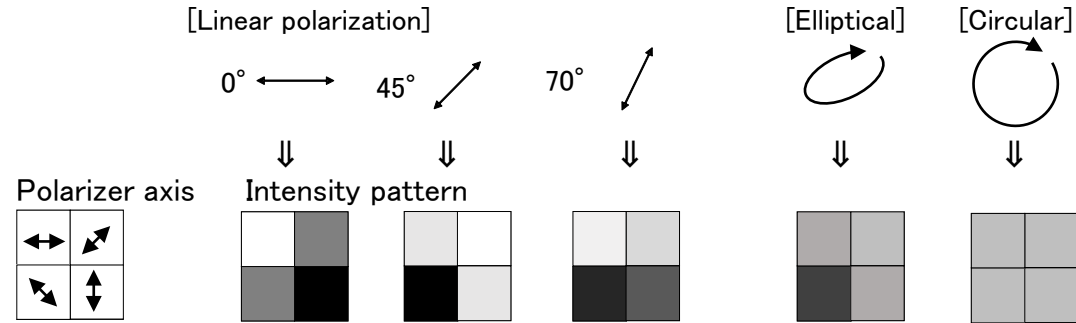

[Computation principle]

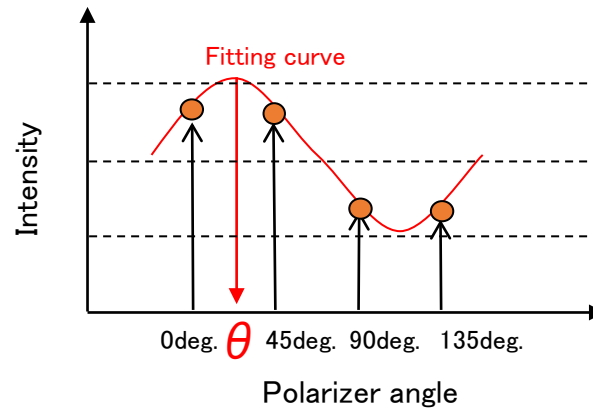

Intensity is supposed to describe a sinusoid
By knowing only 4 points of the curve, it is possible to
recover the whole set of information for any input polarization

Polarization imaging sensor principle

Image recorded on the CCD

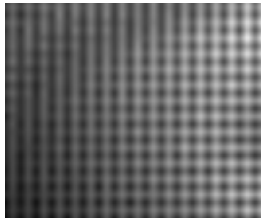
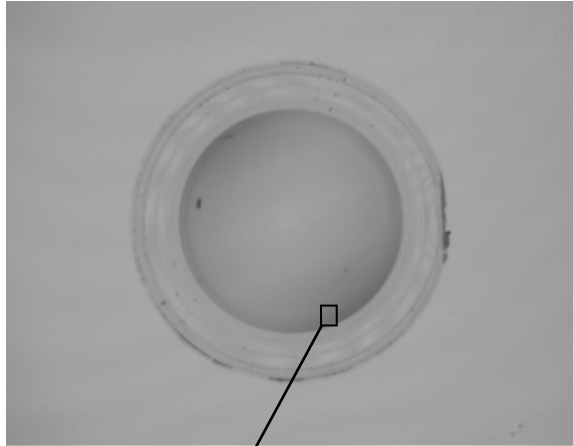

Intensity pattern linked to the state of polarization at each location



Computation & display image

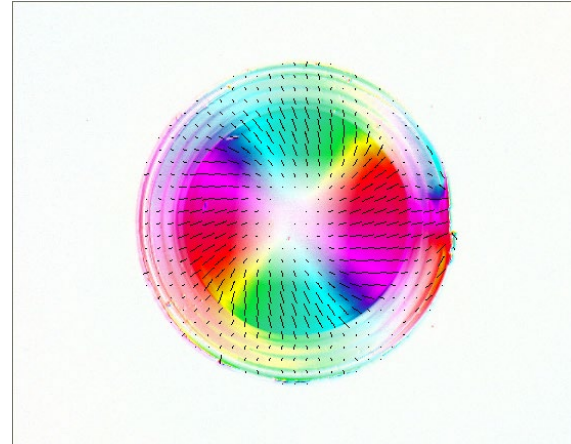

Birefringence data (phase shift and axis orientation) is present at each point as quantitative data.

Phase shift distribution

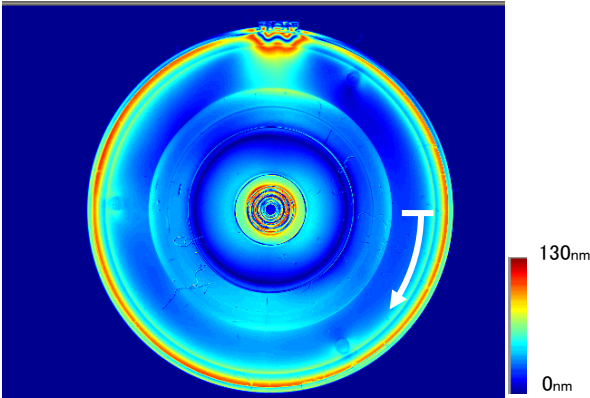

Axis orientation

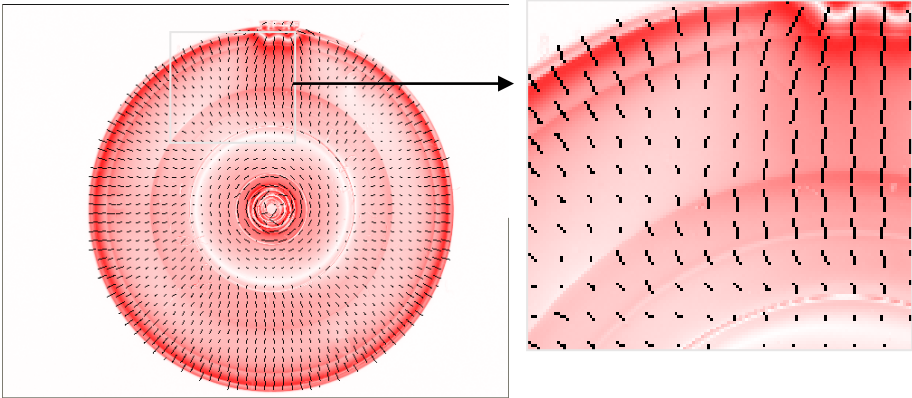

Phase along lens circumference

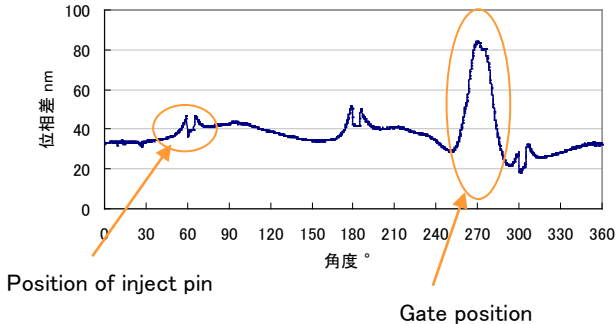

- Detailed quantitative evaluation and comparison is possible between multiple sets of data
- The slightest differences between two sets of data are easy to spot on displayed images

2-D birefringence measurement system
PA Series



3. Basic Structure of the Systems & Measurement Examples

Basic Structure of Birefringence Measurement System and Measurement Method

① Acquisition of state of polarization over light source

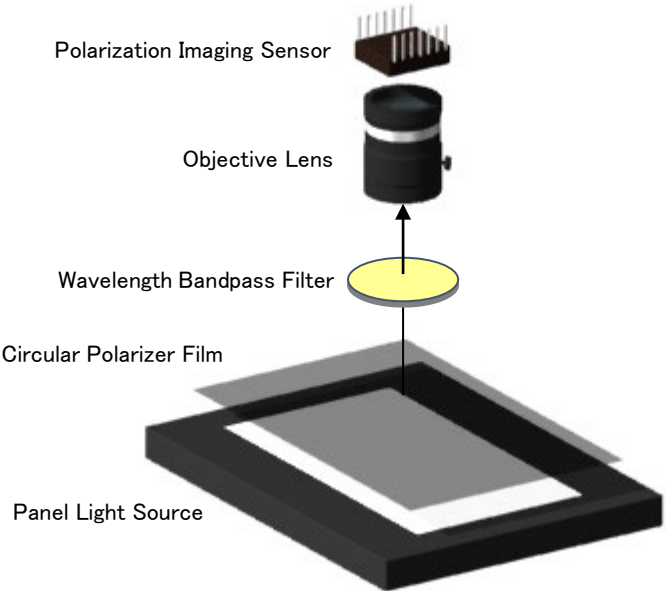

② Acquisition of state of polarization with sample

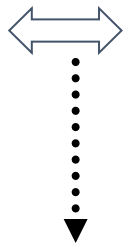
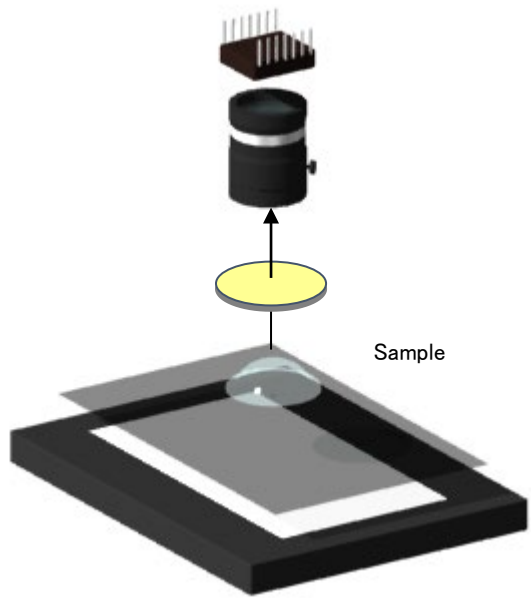

③ Birefringence (phase shift & axis orientation) at each point by comparison of the states of polarization



Why using circular polarizer film
If we used a linear polarizer, the regions of the sample having the same axis orientation as the film would not be correctly evaluated (no sensitivity).
Circular polarizer film allows to obtain the same sensitivity to birefringence independently from axis orientation.

Plastic Molded Lens:
Distribution of Axis Orientation

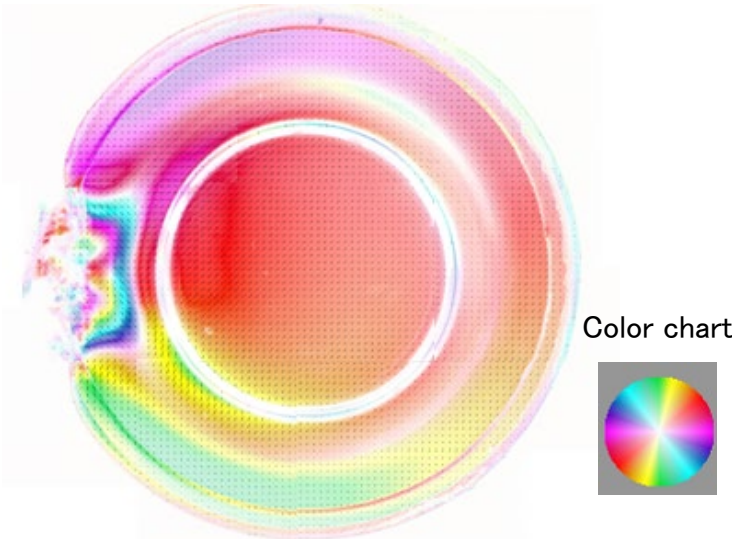

Optical quality glass : phase shift distribution

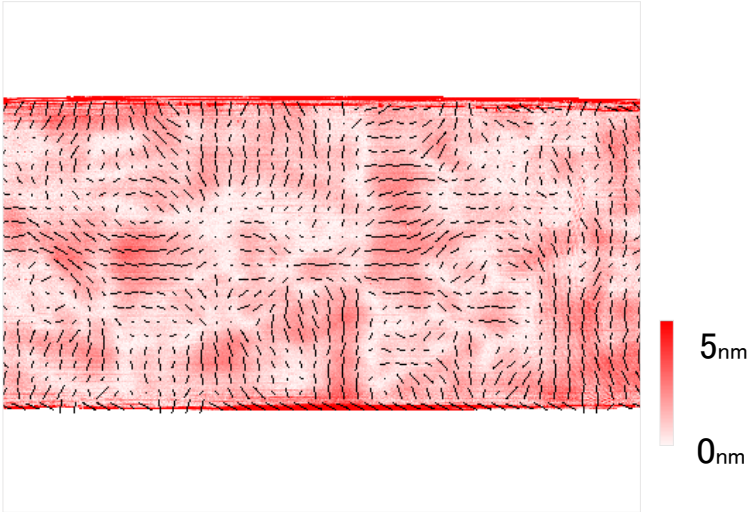

Easy evaluation of the distribution of birefringence over the surface

PA System : Measurement Example (2)

PA Series include a model for microscopic applications, enabling evaluation of very small samples.

Cross-section of optical fiber: birefringence evaluation

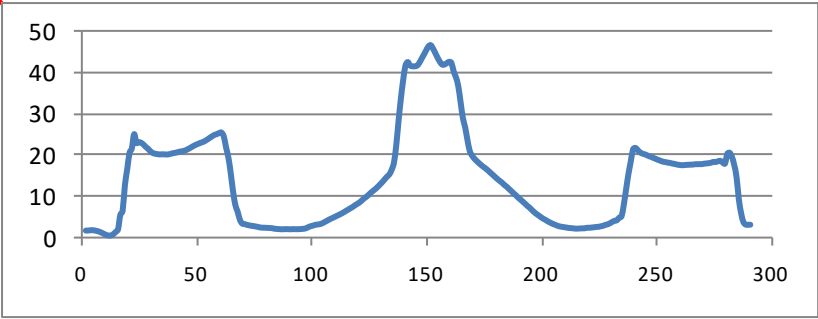
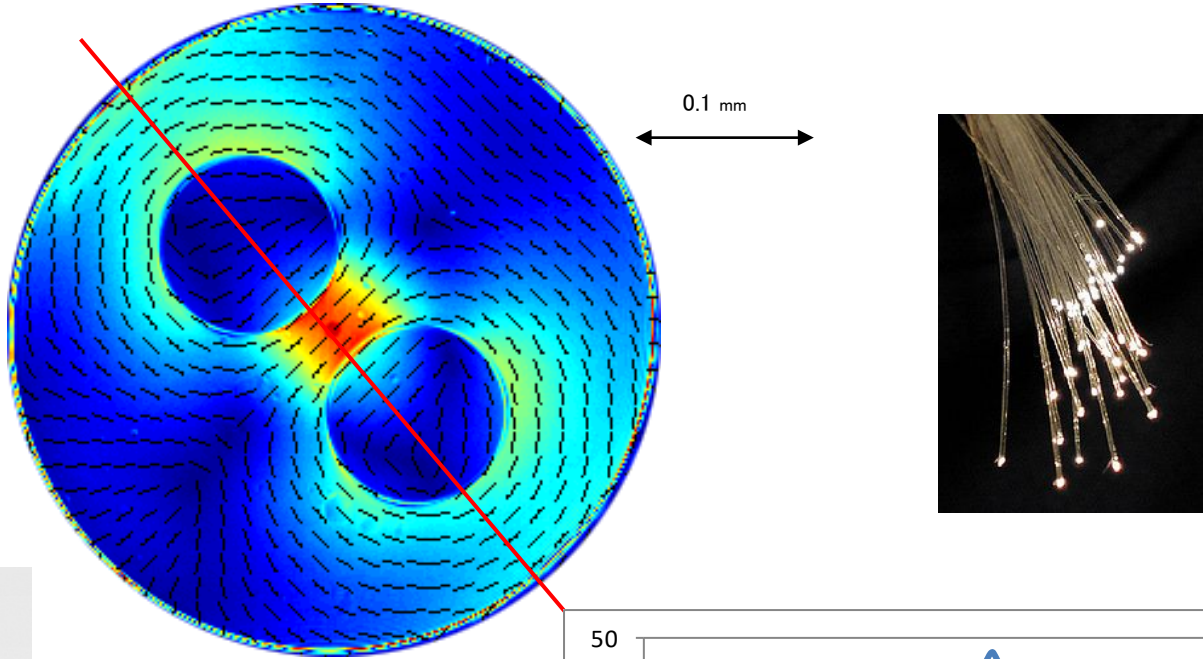

Graph along straight line

PA System : Measurement Example (3)

Plastic molded part (test piece) : evaluation of the differences between materials

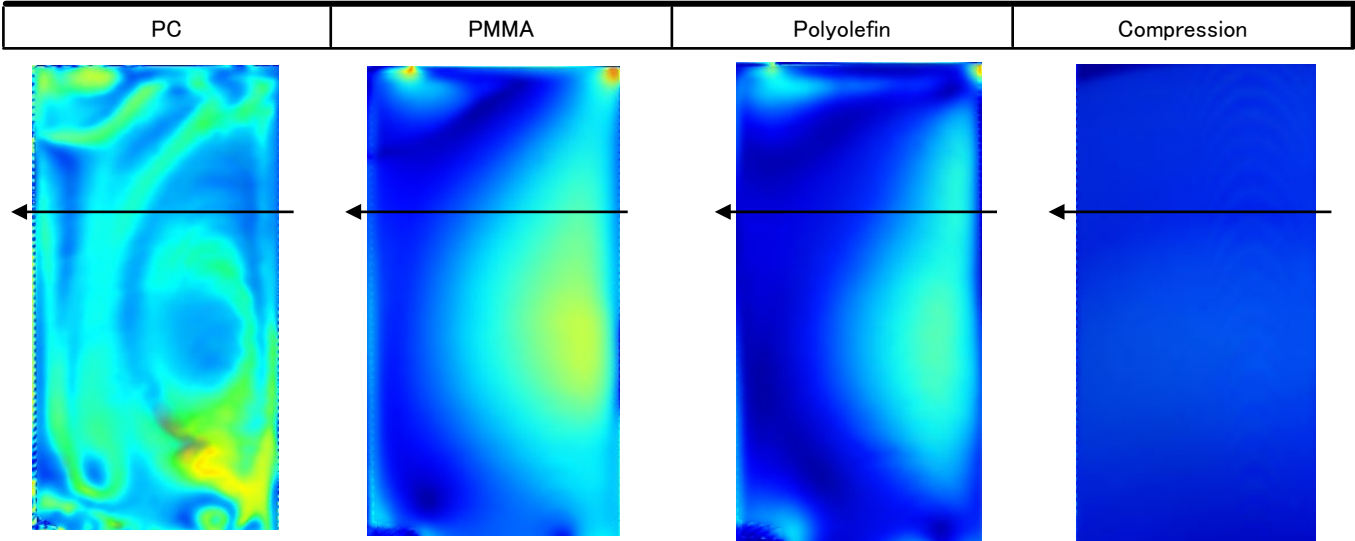

Phase shift along transversal line

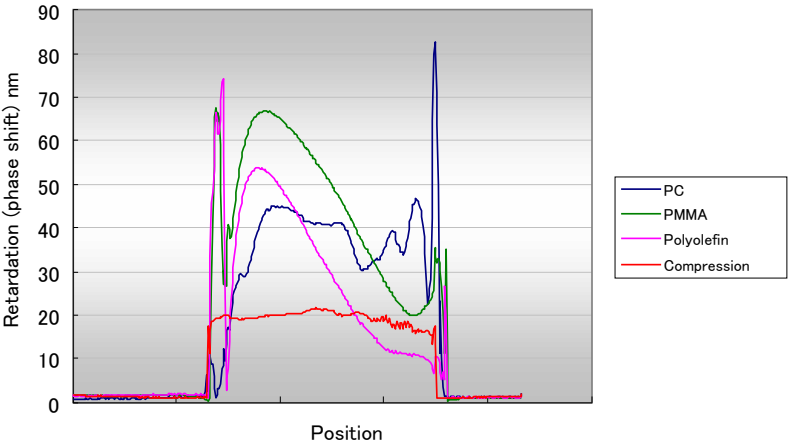

Differences of material & molding parameters appear clearly as differences in the birefringence profile.

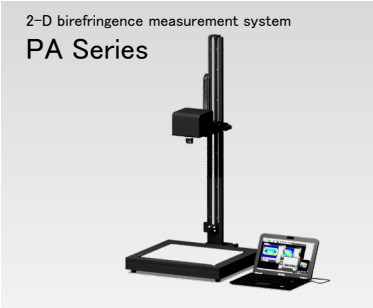

Range limitations of PA Series systems

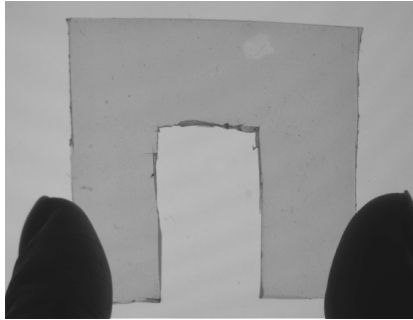

The maximum birefringence that can be measured by PA system is $\lambda / 4$.
Samples exhibiting greater retardation will be displayed with wrapped around values.

Evolution of recorded retardation for growing applied force on test piece (photo-elastic)

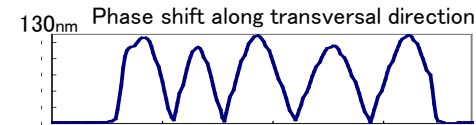
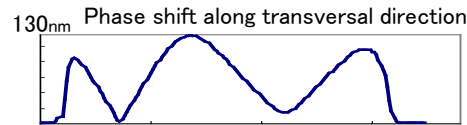
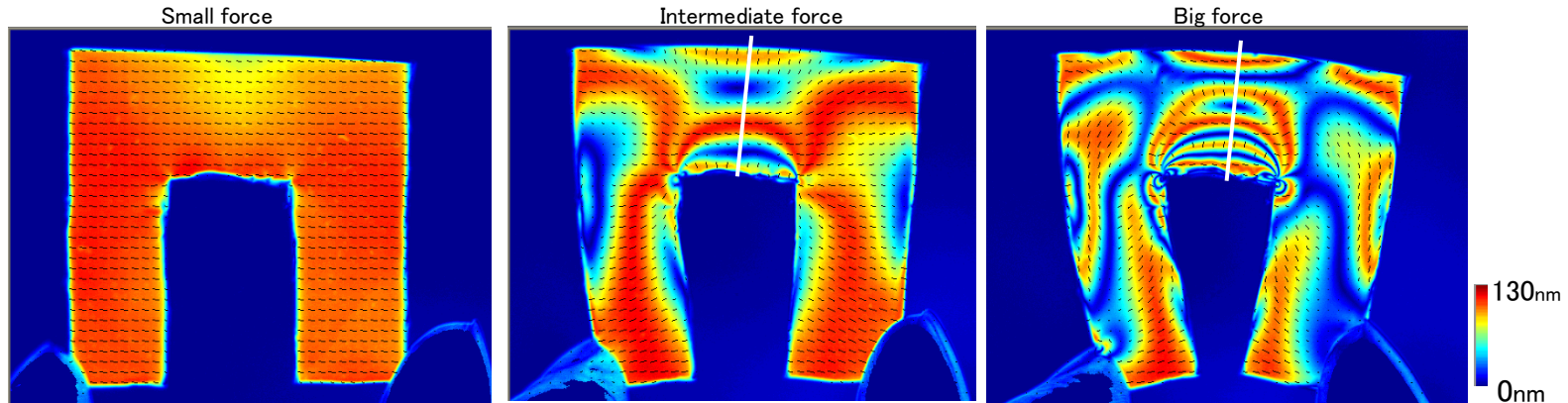

Values over $\frac{1}{4}$ of operating wavelength (520nm) are wrapped around.
It can result in ripples that do not exist in reality.



PA Series is limited to the evaluation of samples of less than 100nm of birefringence

4. Range Limitation and its Solution (WPA Series)

【 Sensor Structure Comparison 】

◆ PA Series

Integrated Polarizer array + CCD sensor
→ Same principle as Rotating Polarizer method

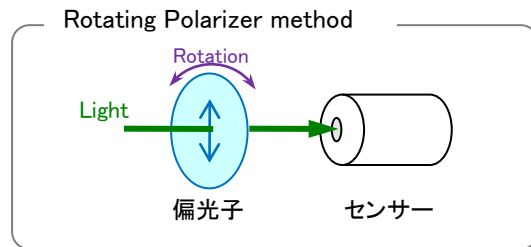
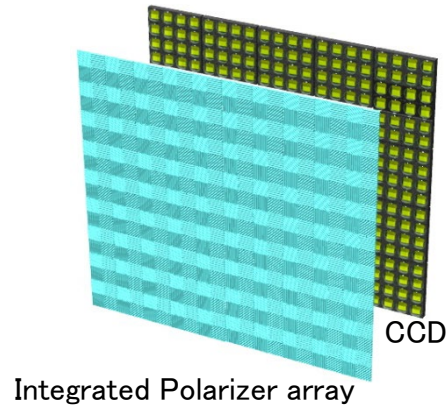

◆ WPA Series

Integrated **Phase-Plate** array + uniform polarizer + CCD sensor
<3-layer unique sensor technology>
→ Same principle as Rotating Phase Plate method

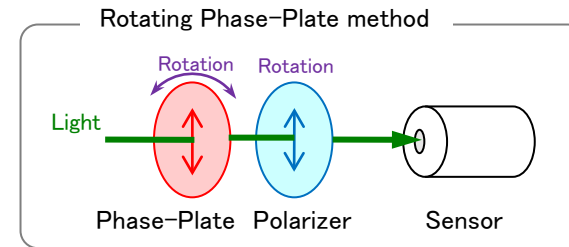
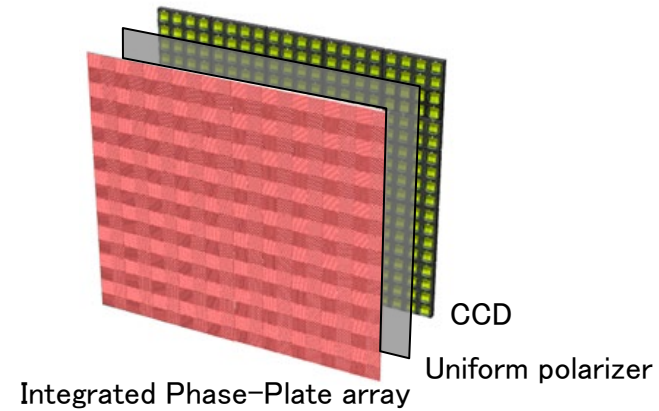

Due to the difference of principle, measurement range of WPA is twice bigger
(see next page)

Range extension (1) Rotating Polarizer vs. Rotating Phase Plate

Principle: compute polarization from the brightness profile obtained when rotating filter

- When filter = polarizer, left-handed and right-handed states look the same
- When filter = phase plate, both left and right-handed states can be measured

『 Measurement range for Rotating Phase-Plate is bigger 』

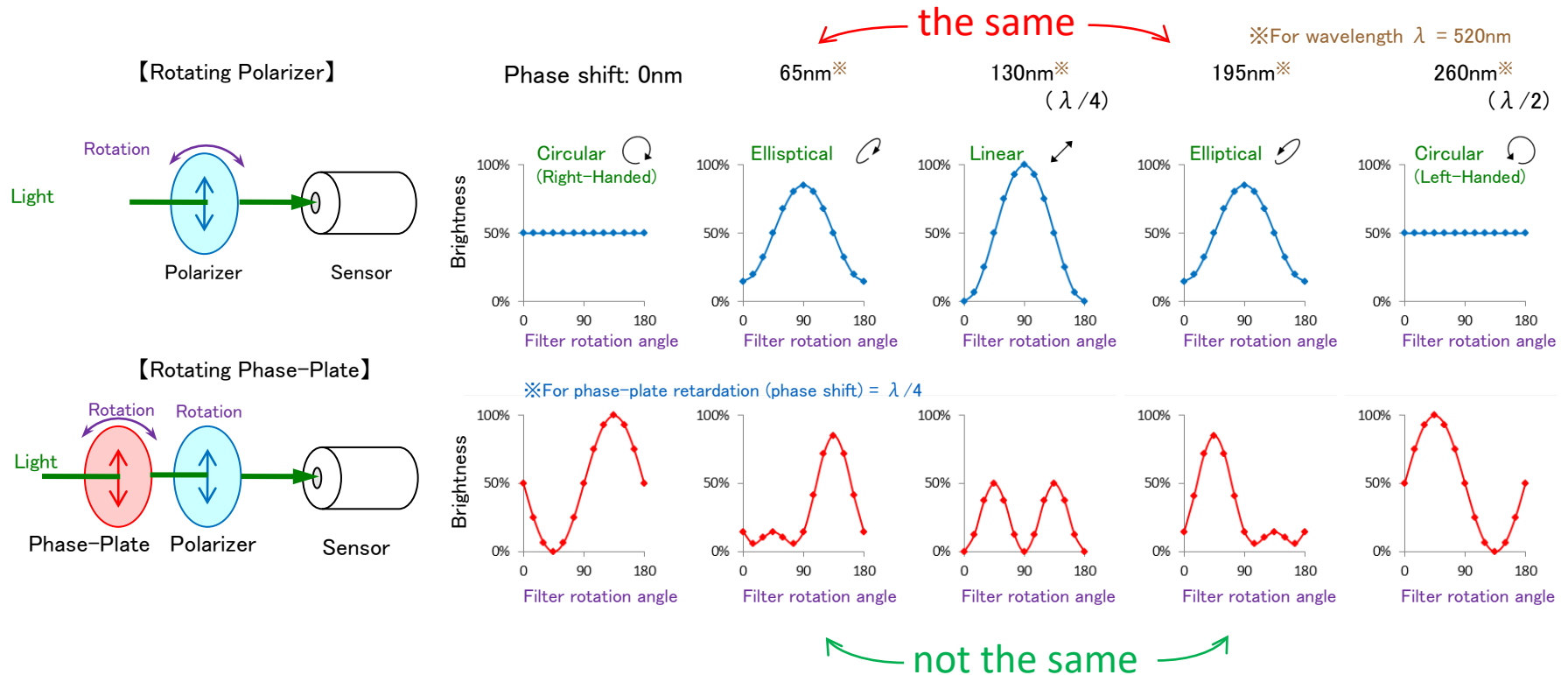

Range extension (2) Multiple Wavelength Measurement

In addition to the improvement in the measurement principle, as a modification of the polarization sensor, using multiple wavelengths allows another improvement in the measurement range.

◆ Reason of measurement range extension

With only one wavelength, phase shifts greater than one wavelength (modulo wavelength) look the same.

→ Comparing data at multiple wavelengths allows making the difference

【See figure on the right】

Let's assume that we want to determine the value on the horizontal axis using one value, α , on the vertical axis. It is easy to convince ourselves that there are several solutions, $A, A + \lambda, A + 2\lambda, \dots$ between which we cannot choose. However, if we have several values for two different curves (for example the red curve and the green curve on the figure), we can now choose one unique correct solution.

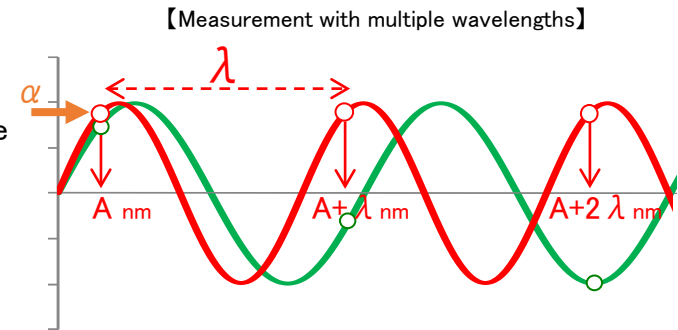

◆ System structure

PA System uses one single wavelength selection filter centered at 530nm, while WPA uses a revolving filter allowing switching between multiple measurement wavelengths.

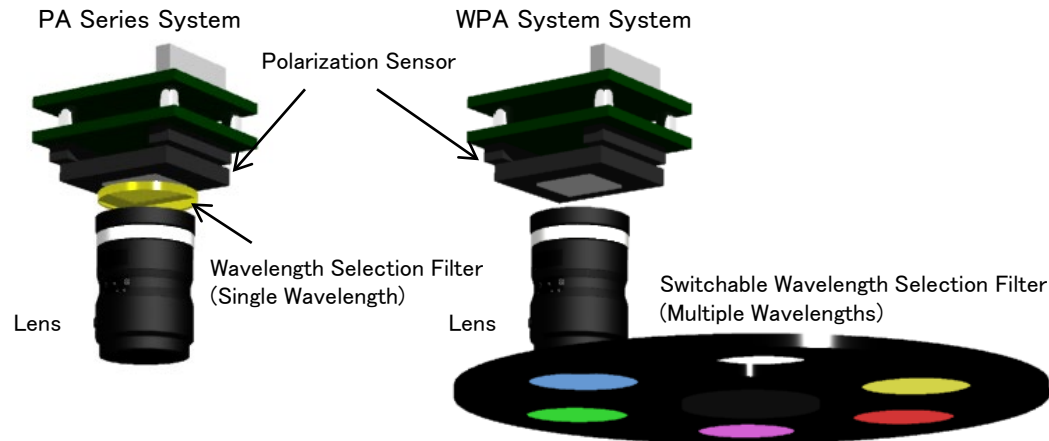

Actual system: PA Series and WPA Series

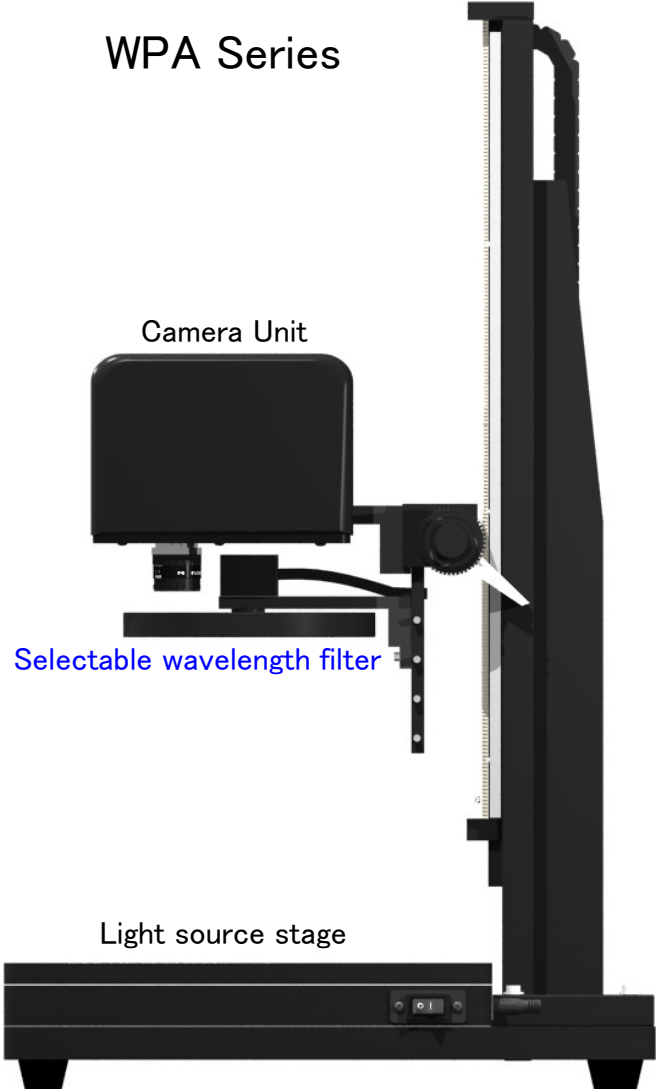
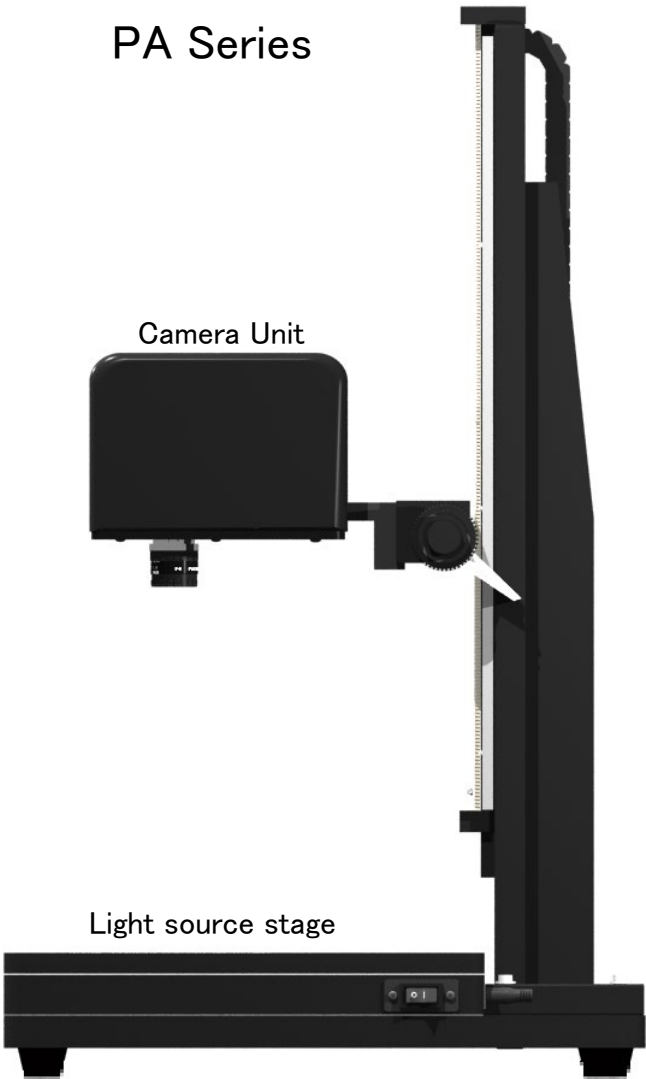

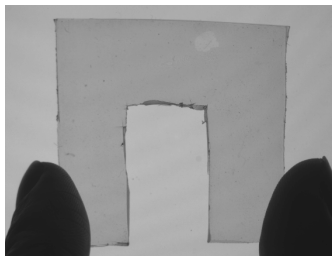

Measurement of retardation > 1 wavelength is available

Evolution of measured value with increasing applied force.

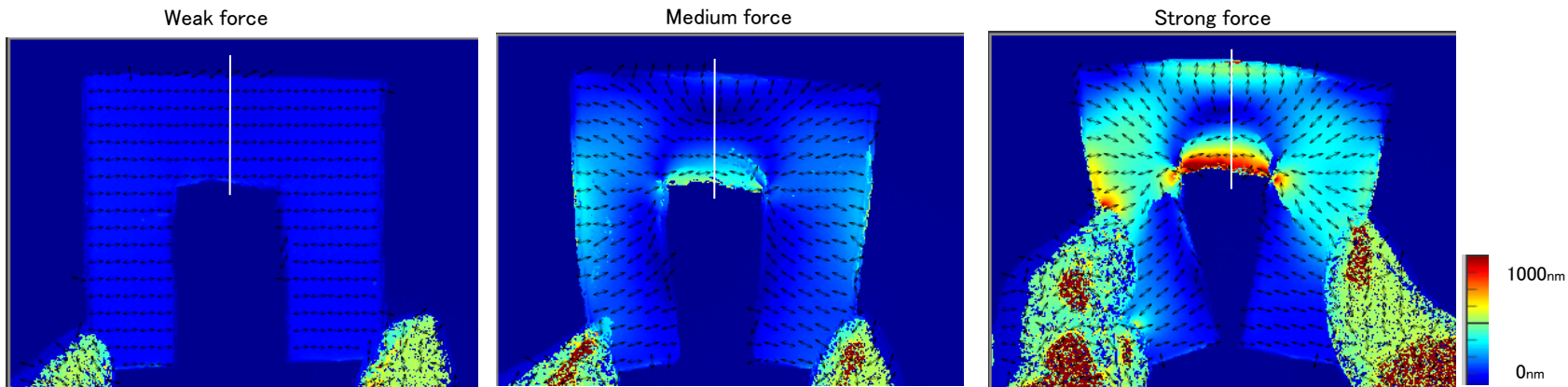

Line profile

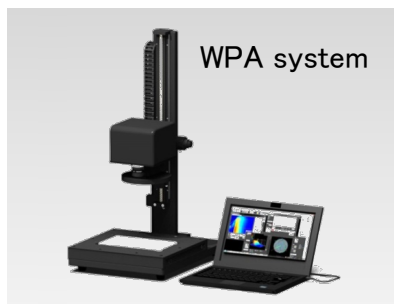

◆ Plastic lens, birefringence ranging from 0 to approx. 800nm

【Data acquired with PA】

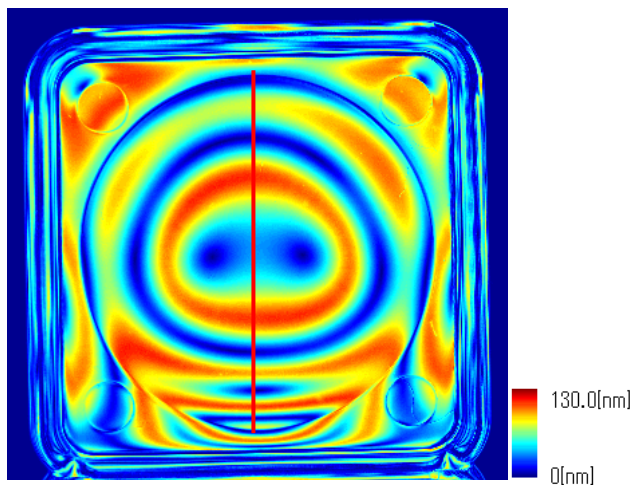

【Data acquired with WPA】

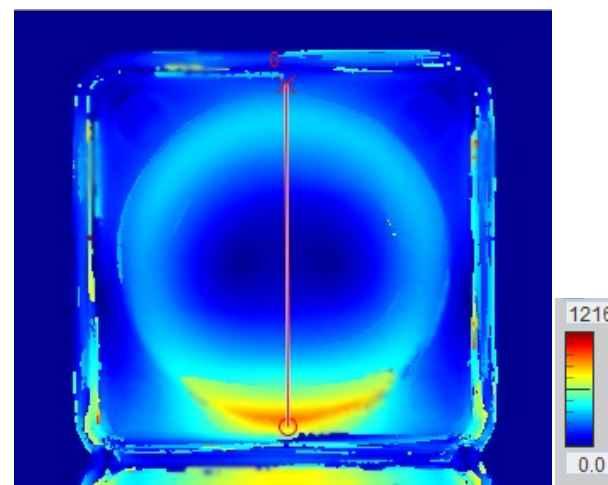

Line profile for both data sets

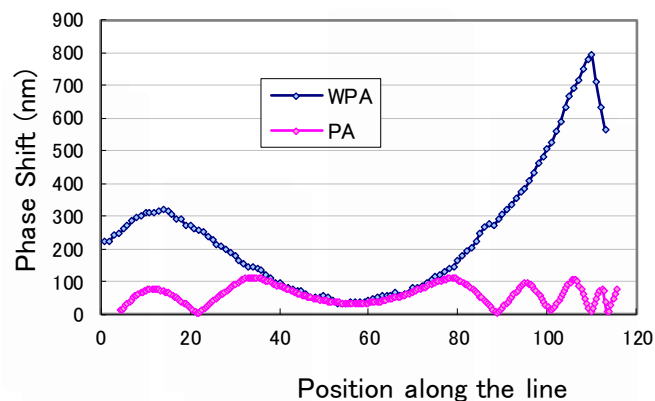

- With PA, data is wrapped around 100nm, while WPA allows acquiring correct values.
- Even areas with much greater values on the periphery are captured correctly with WPA.

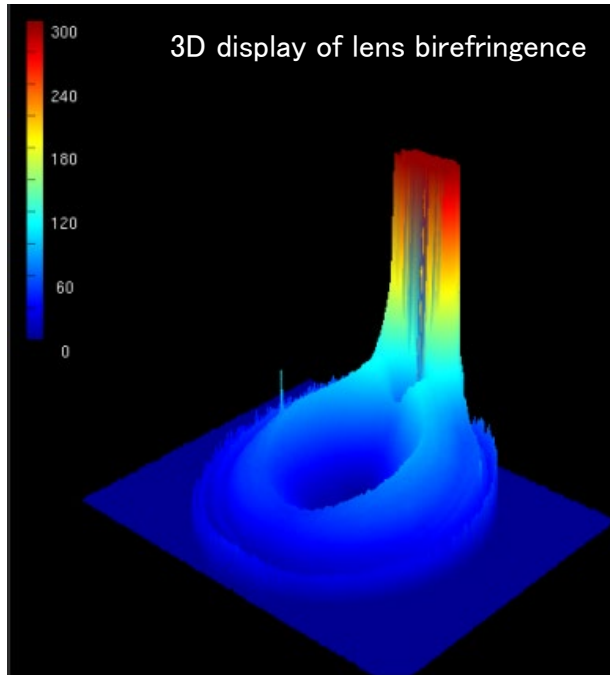

- Principle of birefringence measurement was exposed
- The design of its key part, the polarization sensor, its structure and its operation, was explained
- We presented PA and WPA system, with sample data for comparison

Please feel free to contact us for further details!

株式会社フォトニックラティス
Photonic Lattice, Inc.
URL: <http://www.photonic-lattice.com>
e-mail: info@photonic-lattice.com